



# Isaac Dickson Elementary School PTO Meeting

April 16, 2018





# Agenda

1. Announcements and updates on School Projects
2. Kate Lalor and Bo Royer—Read to Succeed
3. Laura Lane on upcoming changes to Title I
4. Daniel Withrow with an update on the North Carolina Association of Educators
5. Budget Status
6. Open Mic

# Remember to



- Like us on Facebook
  - **Isaac Dickson Parents and Families**
    - Upcoming events and general news
- Check out our web site
  - **idespto.org**
    - News about upcoming events
    - Meeting agenda and minutes
    - Committee information
    - Budget documents
- Email us at  
[isaacdicksonelementarypto@gmail.com](mailto:isaacdicksonelementarypto@gmail.com)

All parents, guardians and teachers are members of the PTO. We welcome your suggestions and need your input and help to make Isaac Dickson the best school it can be.

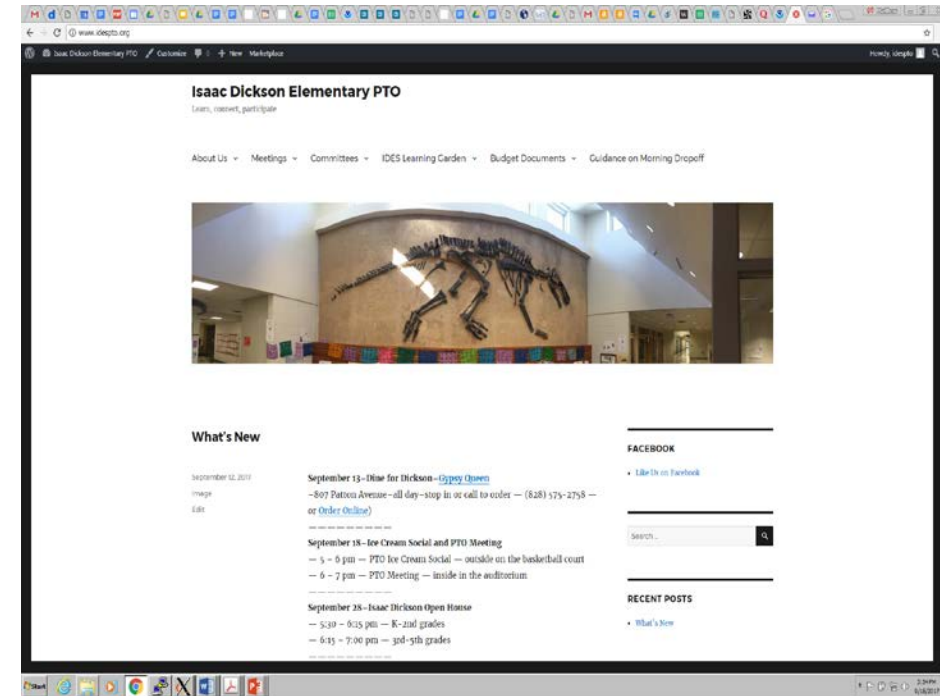

# IDES Meeting Schedule

- General PTO Meetings
  - Third Monday of the Month (with some exceptions)
  - Next Meeting would be May 21st in the media center
    - Considering having an end of the year potluck instead
  - These meetings are devoted to showcasing grade level activities, bring in community speakers and other topics that are of more general interest to parents
- Leadership/Work Session Meetings
  - (Usually) First Tuesday of the Month in the media center
  - Next Meeting May 1 @ 5:30 pm in the media center
  - These are work sessions devoted to details such as budget and event planning. **Everyone is welcome to attend!**



# Announcements



# Dickson Talent Show

April 19

6:30 pm

IDES Auditorium





# 5% DAY COMMUNITY GIVING PROGRAM



SHOP WITH US ON THURSDAY, APRIL 19TH  
WHEN 5% OF THE STORES NET SALES WILL  
BE DONATED TO SUPPORT:





# CHOOSING EQUITY

A FOUR PART COMMUNITY SERIES ON INTEGRATION,  
INCLUSION, AND EQUITY IN OUR SCHOOLS

JANUARY  
30

The Legacy of Desegregation in ACS

6:00-8:00 PM HALL FLETCHER ELEMENTARY

FEBRUARY  
28

Ending Racial Inequity in Our  
Schools: What Actually Works?

WITH **NIKOLE HANNAH-JONES**

*Tickets on sale January 2nd at [WWW.ACSF.ORG/NHJ](http://WWW.ACSF.ORG/NHJ)*

7:00 PM UNC ASHEVILLE LIPINSKY AUDITORIUM



MARCH  
22

Promoting Equity Today

6:00-8:00 PM VANCE ELEMENTARY  
FREE EVENT; Food and Childcare will be provided

APRIL  
19

Becoming an Equity Advocate

6:00-8:00 PM ARTHUR R. EDINGTON EDUCATION & CAREER CENTER  
FREE EVENT; Food and Childcare will be provided



# Becoming A Racial Equity Advocate

## April 19 at the Edington Center

- Dinner will be served at 5:45
  - ( please RSVP if possible on the ACSF FB page )
- Program begins at 6:15. ACSF will be exploring the following roles with local groups illustrating their work:
- Support - CAYLA
- Advocate - YTL Advocates
- Organize - Claxton Racial Justice League
- Educate/Train - Building Bridges
- Make Visible - State of Black Asheville

# Stumptown Mural Project

- Mural back drop work began last week
- Work on the raised panel portraits will start with students this week
- Supported by IDES  
PTO and ACSF





Cob Oven!



Supported by Bright Ideas and IDES PTO



# Cob Oven General Build Timeline

- **Thurs, 4/12 :: Tire Foundation with gravel, dirt, & rubble infill**
- **Fri, 4/13 :: Cob Base Plate & Bottle Insulation**
- **Mon, 4/16 :: Firebrick Floor, Sand Dome, & Entrance Tunnel**
- **Tues, 4/17 :: Thermal Mass Layer & Cob Outer Shell**
- **Wed-Thurs 4/18-19 :: Insulation & Cob Outer Shell**
- **Fri, 4/20 :: Cob Shaping & Sculpting**
- **Mon/Tues, 4/23-24 :: Mosaic Embedding**
- **Wed/Thurs, 4/25-26 :: Finish Plaster & Aliz Paint**
- **WED, May 2 :: Oven Firing Celebration**
  - 8am Start fire in oven
  - 11am Ribbon Cutting Ceremony
  - Noon-2:30 Pizza making

# Shade for our K-2 Playground

- Designed by the IDES Garden Team
- Support by a grant from the Faile Foundation
- Building permit has been pulled—bounced back and forth between city and county
- Now under review by county. Construction to begin pending engineering review



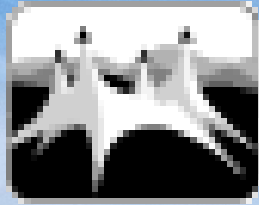

# Artful Shelter

[artfulshelter.com](http://artfulshelter.com)



## Isaac Dickson Shade Sail - Visual Simulation

DISCLAIMER: THIS IMAGE IS ONLY A GRAPHIC ESTIMATION OF THE SHADE SAIL. FINAL SIZE, SCALE, LAYOUT, COLORS AND OVERALL LOOK MAY VARY



# Garden Shed

- Also designed by parents on the IDES Garden Team
- Supported by a grant from the Faile Foundation
- Also caught up in some permitting confusion by city and county. Looks like from now on, it is the county that will be responsible for permitting for city schools, with the city requiring its own permit for zoning.
- Construction to take place in mid-June by Artful Pallet

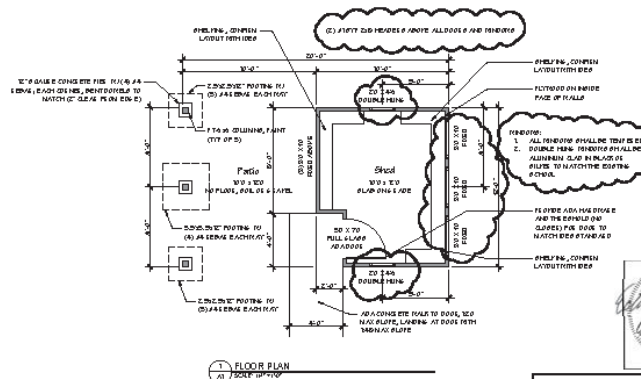
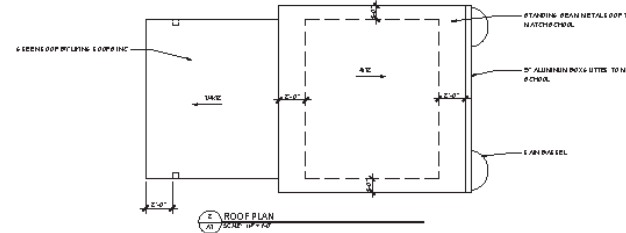
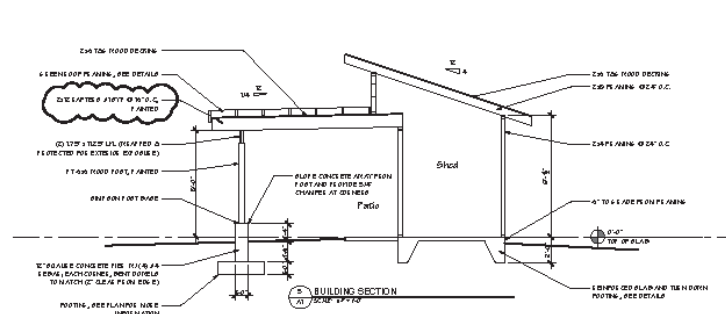
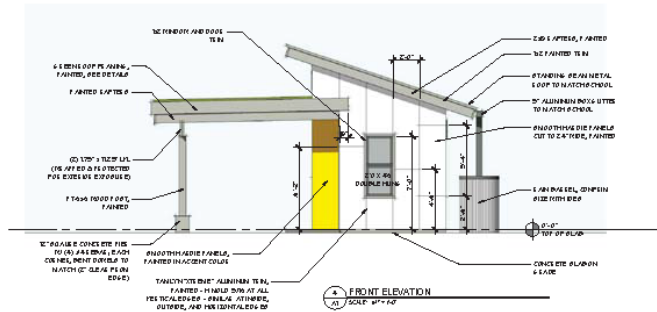
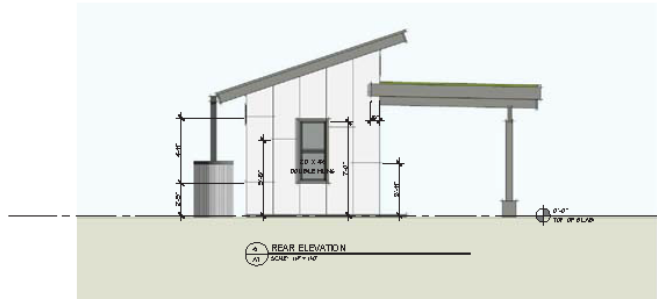
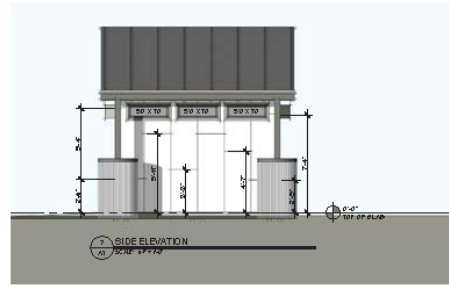

AREA CALCULATIONS	
AREA	= 104 SF
FLOOR	= 104 SF

wilson  
architects  
wearch.com



900 PLYWOOD DR  
WALTON MA RD HITECOTE

IDES GARDEN SHED  
125 Hill Street  
Asheville, North Carolina 28801

PROJECT NO: 11-099  
REVISION SET: 3.16.15  
PERMIT SET: 3.16.15  
REVISED # 01: 3.16.15

SHEET TITLE  
PLANS AND ELEVATIONS

PROJECT NUMBER:  
11-099

SHEET NUMBER:

A1



# **Cultivating Mindfulness at IDES Community Event**

**May 4 & 5**

**Friday, May 4 from 5:30-7:30 pm**

**Saturday, May 5 from 1:00-4:00 pm**

**Childcare provided both days**

And finally,





We need new officers for next year

- Co-presidents and Vice Presidents
- Secretary
- Communications
- Committees to help with social events and fundraisers

To Make the PTO Great Again!!  
(next year)





# Current Assets

<b>ASSETS</b>	<b>Approved</b>	<b>Working</b>	
<b>Starting Balance</b>	on 9/18/2017	As of 02/19/18	
PTO Checking Account	18,737	59,935.17	
PTO Garden Account	9,029	2,079.14	
PTO "Family Support" CD	1,549	1,549	(originated in 2007; was misidentified in draft budget)
PTO K-2 Playground CD	3,434	3,434	(originated in 2009; was omitted in draft budget)
<b>Total Assets:</b>	<b><u>\$32,749</u></b>	<b><u>\$66,997.31</u></b>	

# Income since 9/18/2017

<b>INCOME</b>	<b>Last Year</b>	<b>Approved</b>	<b>Working</b>
Breakfast of Hope	19,720	16,000	19,405
Dine for Dickson	555	1,500	576
Hot Chocolate Race	15,408	14,000	24,761
Faile Foundation Grant for Garden Spaces			20,000
<b>Total</b>	<b>35,683</b>	<b>31,500</b>	<b>64,742</b>



# Upcoming Expenditures

<b>Expenses</b>	<b>Approved</b>	<b>Working</b>	
Artist in Residence	3000	3000	
Community Art Project	2000	2000	
Field Trip Support	9200	9200	
Teacher Grade Level/Staff Stipends	15,600	7800	
Garden Projects (Faile Foundation)		20,000	
<b>Total</b>		<b>42,000</b>	

# Open Mic





The sun will power our children's future

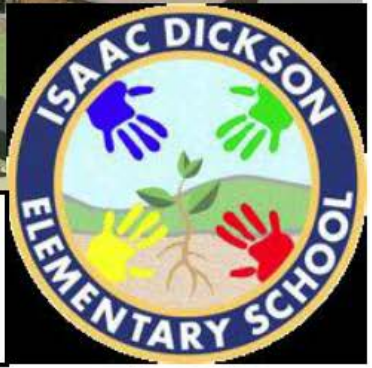

THANK YOU!!